

# ABOISTOP ELECTRO

## USER MANUAL

D157010

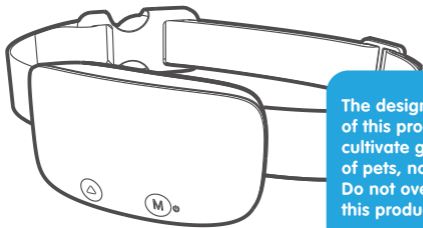

The design concept of this product is to cultivate good habits of pets, not punitive. Do not overuse this product on pets.

**NOTICE**



Please read the user manual carefully before use and keep it in a safe place!



Please  
Next Page

# D157010

---

## Specifications











Product name:	Aboistop Electro
Product model:	D157010
Operation voltage:	3,7 V
Battery capacity:	300 mAh
Rated input:	DC 5V / 1A
Waterproof rating:	IP67
Operating temperature:	-10 °C - 50 °C
Storage temperature:	-20 °C - 60 °C
Device volume:	70mm*37mm*40mm
Net weight:	90 g

Made in China



# Contents



	<b>Important safety information</b> .....	<b>1 2 3</b>
	<b>What's in the box?</b> .....	<b>4</b>
	<b>Learn about your collar</b> .....	<b>5 6 7</b>
	<b>How does the collar works?</b> .....	<b>8 9 10 11</b>
	<b>How to operate?</b> .....	<b>12 13 14 15 16 17 18 19</b>
	<b>How to wear?</b> .....	<b>20 21 22 23 24 25</b>
	<b>FAQ</b> .....	<b>25</b>
	<b>Troubleshooting</b> .....	<b>26</b>
	<b>Term of use &amp; limitation of liability</b> .....	<b>27</b>
	<b>Certification statements</b> .....	<b>28</b>

# Important safety information

# 1

## Explanation of attention words and symbols used in this guide.



This is the safety alert symbol. It is used to alert you to potential personal injury hazards. Obey all safety messages that follow this symbol to avoid possible injury or death.

### **WARNING**

**WARNING** indicates a hazardous situation which, if not avoided, could result in death or serious injury.

### **CAUTION**

**CAUTION**, used with the safety alert symbol, indicates a hazardous situation which, if not avoided, could result in minor or moderate injury.

### **CAUTION**

**CAUTION**, without the safety alert symbol, is used to address practices not related to personal injury.

### **NOTICE**

Notice is used to address practices not related to personal injury.



**PROHIBITED**, indicates that the operation is prohibited.

# Important safety information

# 2

## Safety instruction for this product



### WARNING

It is forbidden to be used on aggressive dogs. An aggressive dog may cause serious injury or even death to the owner or others. If you are not sure whether this product is suitable for your dog, please consult a professional dog trainer.

Children are prohibited from playing with this product. Keep collar away from children.



### CAUTION

Please make sure your dog is healthy before using the product. If you are unsure about this, please consult your veterinarian.

When the collar is turned on, the human body should not directly touch the e-shock contact of the product.

If rash or sore is found at the contact location of E-shock, please stop using this product until the skin recovers



# Important safety information

# 3

## Safety instructions for this product



### CAUTION

Collar wearing time should not exceed 12 hours per day, and please adjust the wearing position every 1 to 2 hours.

This product is suitable for dogs over weighing more than 8 pounds and the age of 6 months

It is forbidden to use this product as a matching collar for pet leashes.



### CAUTION

It is important to check the E-shock contact area of the dog's neck every day for Rashes & Sores.

The long hair around the dog's throat can be properly shortened but it is not recommended to be completely shaved.

Please remove the collar before playing with the dog. Avoid false triggers.



# What's in the box ?

# 4

## Components

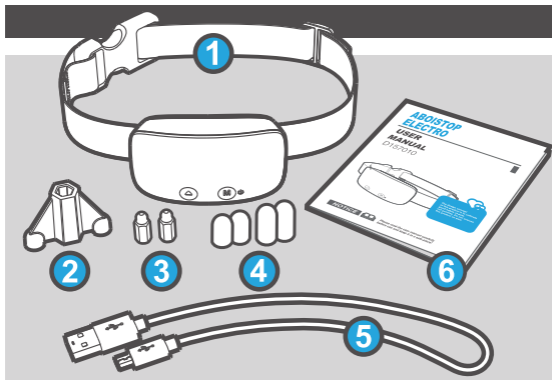

1. Aboistop Electro Collar .....	1
2. Test unit & probe driver .....	1
3. Long E-shock probes .....	1 pair
4. Probe protective cover .....	2 pair
5. USB charging cable .....	1
6. Quick start card + User Manual on line.....	1

\* *The shorter E-Shock probe has been assembled on the collar.*

# Learn about your collar

# 5

## Introduction of components

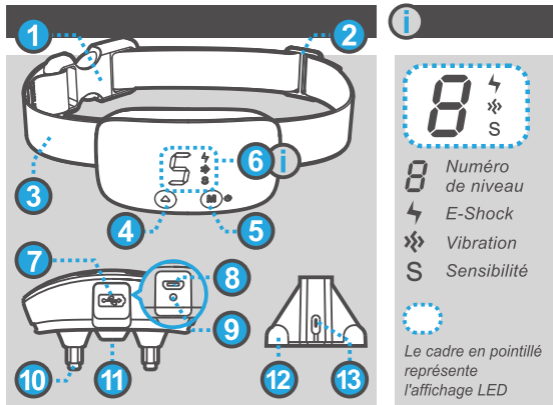

1. Buckle
2. Slider buckle
3. Adjustable strap
4. Adjust level/ Enter setting mode
5. Power On & Off Checking Switch mode

6. LED display **i**
7. Rubber plug
8. USB charging
9. Reset
10. Eshock probe
11. Sound sensor
12. Test contact mount
13. Test light



# Learn about your collar

# 6

## Features



### Features for dogs



Sound  
trigger



Sensitivity  
level



Freely combined



Output  
level



Total  
combination

### Features for people



Touch  
button



See easily  
day & night



Water-  
proof



Maximum  
circumference



Long & short  
probe



USB  
charging



Smart  
control



Long  
standby



Test  
unit



Reset

# Learn about your collar

# 7

## Main features introduction



### Trigger Methods

Sound  
trigger



1-7 level sensitivity.  
Defaults setting is 6.

### 2 Working modes

Sleeping  
mode



No barking for 5 secs,  
sleep mode begins

Training  
mode



Dog is barking,  
training mode activated

### 3 basic training methods

Beep



Always exists and cannot be  
cancelled. No level setting

Vibration



0-7 level output setting.  
0 is off. Default is level 3.

E-shock



0-7 level output setting.  
0 is off. Default is level 0.

# How does the collar works

# 8

## Principle of barking prevention



### A STAGE

The collar is triggered by dog barking



### B1 STAGE

Three ways to stop barking work in order



### B2 STAGE

Three ways can be grouped by turn ON or turn OFF

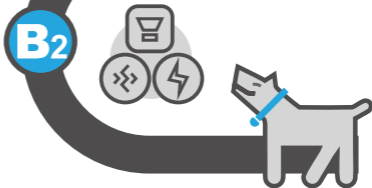

# How Does the Collar Work

# 9

## How the Main Features Work



### How to trigger

**A**

### STAGE



Dog barking



Sound sensor



Features are triggered



Barking volume



Sensitivity level



## Trigger Based on Two Principles



### Sound Waves Matching

We exclude common interference waveforms, while optimizing dog barking waveform recognition.



### Volume trigger

Sound volume intensity recognition, sensitivity level is inversely proportional to volume.

*Through these two basic acoustic principles, we have improved the accuracy of product triggering to enhance the ability to resist false triggers. For detailed instructions, see page 14,15 and 16*

# How does the collar work

# 10

## How the main features work



### Training & tips

### B1 STAGE

Beep training



Make sounds



*The design concept of this product is to cultivate good habits for pets, not to be punitive. Please follow the instructions of the manual to use this product correctly.*

Vibration training



Display



E shock training



Display



### Execution order



This means that with both vibration and e shock functions turned on your dog will hear the beep first, then vibration will occur. Then shocking will occur.



4 workgroup types

# How does the collar works

# 11

## How groups work



## How groups work

### B2



### CYCLE/SUSPEND

One trigger one group

Trigger continuously output continuously, 7 times & break loop

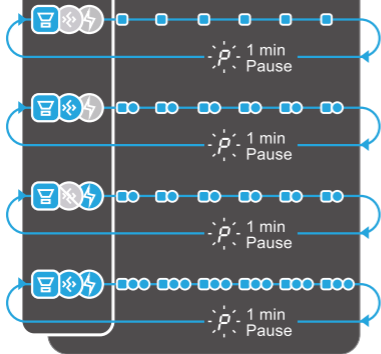

*Bleu means the function is On*



*Gray means the function is Off*

### 64 combinaisons

Combining 4 working groups with level settings this collar can perform 64 training combinations.



*To protect the dog, whether the dog is still barking or not it will pause for of one minute after 7 triggers.*

# How to operate

# 12

## Basic operation



### Power On & off



Long touch to turn on



Must enter setting mode for turn off, see page 13 for instructions to enter setting mode.



Long touch to turn Off



### To view function settings



These three symbols represent the feedback of the collar to the operation.



4

E shock 7 is highest choc 0 is off

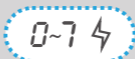

3

Vibration 7 is highest vibration 0 is off

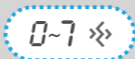

2

Bark sensor 7 is most sensitive



1

Battery indicator

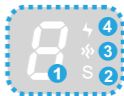

Short touch **M** to toggle through and view settings and battery level











# How to operate

# 13

## Setting operation



### Functions setting process

-  Short touch to wake up device  

-  Tap 3 times to enter setting mode  

-  Tap to switch functions  

-  Tap to adjust level  

-  **Stop!** Stop settings are set display goes a way. Automatically exit setting mode after 3 secs
-  Long touch to turn off  



These three symbols represent the feedback of the collar to the operation.

The step  is the turn off step

The default setting for the collar is sensitivity sensor level is 6. Vibration level is 3 E shock level is 0.



# How to operate

# 14

## Setting guidelines



### General setting guidelines

#### Sensitivity setting



Theoretically, the louder the barking sound, the lower the sensitivity level

#### Beep setting



No setting required for well trained dogs

#### Vibration setting



Low discomfort training method. Suitable for most dogs

#### E shock setting



High discomfort training method. More suitable for large dogs and high tolerance dogs



### ⚠ CAUTION

Whether it is a large dog or a small dog, please gradually increase the level of e shock from level 1.

# How to operate

# 15

## Setting guidelines



### Other setting considerations

**Well-trained**



For trained dogs, please only use the beep feature or low level settings.

**Body Size**



Small dogs gradually increase from a low level.

**Tolerance**



Dogs with high endurance need higher training levels.

**Numerous dogs**



Reduce the sensitivity level to fit just one dog to avoid false triggering.

**Bad mood**



Do not use this product when pets are upset and depressed.

**Ambient noise**



Reduce the sensitivity level to avoid false triggering.

# How to operate

# 16

## Setting guidelines



### General advice

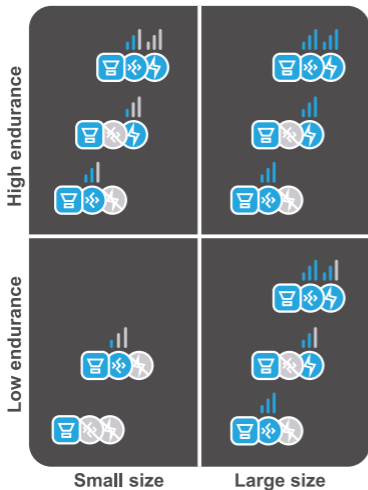

The default setting is medium intensity training. If you think the default setting is suitable for your dog, you can have your dog wear it without adjusting settings. Please refer to page 19 for how to. Assemble and wear.



Blue means the function is On.



Gray means the function is Off.

# How to operate

# 17

## Battery & charging



### Battery indicator

Low battery



Battery level



Full battery



Short touch <sup>(M)</sup>  
to view  
battery level.

When out of the battery,  
the collar will automatically  
shut down after the prompt  
flashes for 30 seconds.



It is recommended  
to turn Off the collar  
after each use.  
This can greatly  
extend the standby  
time.

### Battery charging

At 2 level battery indicator,  
please begin charging.

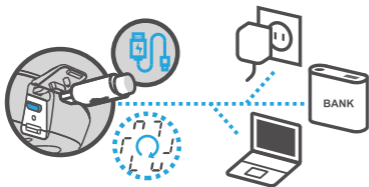

The dotted frame  
represents  
the LED display.

# How to operate

# 18

## Waterproof key operation



### How to tighten the USB rubber plug

For the good waterproof effect of collar, please make sure that the operation steps and methods of tightening the waterproof plug are correct. When the dog is playing or swimming in the water for a long time, please remove the collar.

Complicated dynamic usage scenarios will affect the waterproof performance of the rubber stopper and may also cause false triggering.



*IP67 means the unit can be dropped into a body of water up to a meter deep for half an hour, and it is dust-proof. This is the static test result in the laboratory.*

### CAUTION



1 Pull the root of the rubber stopper to the limit.



2 Keep the rubber plug parallel to the product surface. Align the 3 plug columns vertically to the hole.



3 Press the rubber plug vertically. Ensure that 3 columns fill in the holes.

# How to wear

# 19

## Assemble the collar



### Probes assembly

The shorter probe is already installed on the collar.  
If it is not long enough, please replace the long probe yourself.

1



Select  
probes

2



Mount probes

3



**OK!**

### Probe protective cover

The silicone protective cover can be applied to the probes to protect  
the dog's skin from shock or irritation.

1



Select  
covers

2



Put on  
directly

3



**OK!**

# How to wear

# 20

## Main features test



### Test e shock feature

When the collar assembly is completed it is recommended to perform a main feature test. Please follow the procedure below to test. The e shock feature needs to be tested through the test unit.

- 1** By setting turn on the vibration function and e shock function
- 2** Blow into the sensor to trigger the product. Beep vibration and e shock will be executed one by one.
- 3** The e shock feature needs to be tested with the test unit. If the e shock feature works normally the test light will light up.
- 4** The higher the e shock level the brighter the light.

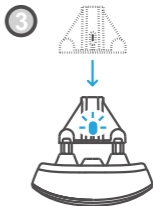
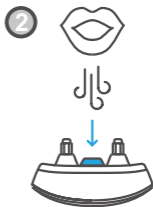

# How to wear

# 21

## Warning & cautions



### Applicable Dog Range for Wearing

Please pay attention to the following conditions before wearing this collar for dogs.

#### ⚠ WARNING

For aggressive dogs, use is prohibited. Otherwise, it may cause potential bites to humans.



#### ⚠ CAUTION

Please make sure your dog is healthy before using the product. Please consult a veterinarian.

This product is suitable for dogs over weighing more than 8 pounds and the age of 6 months.

The long haired dogs can moderately shorten the hair at the throat but shaving is not recommended.





# How to wear

# 22

## Wearing steps



### Wearing steps

The dog's neck circumference ranges from 8in to 25in (20cm-60cm). Please set up the collar before wearing for the dog.

1

Adjust the buckle position and determine the length of the strap. Place the slider buckle and device in the position shown in the figure.

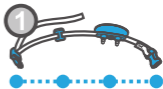

2

Insert the extra strap into the slider buckle. Prepare for wearing.



3

Wear the collar around the dog's neck in a personally comfortable way.



4

Adjust the position of the device to the position of the dog's front throat. Adjust the tightness of the strap to the best condition and make. Sure that the probes touch the skin.



# How to wear

# 23

## Wearing points



### Key points for working fine



Vocal cord  
position



Collar tight  
enough



Good  
skin contact

**CAUTION**

### Comfort wearing



Moderately  
tight



Skin contact  
just fine



Timely  
adjustment

**CAUTION**

### Skin Healthy



Don't wear  
more than 12h



Daily check  
for rash&sore



Keep  
probes clean

**CAUTION**

**Risk  
of skin  
damage**

# How to wear

# 24

## Other precautions for use



### ⚠ WARNING

Please shut down when not in use and keep the product in safe place out of reach of children and pets.



### ⚠ CAUTION

It is forbidden to use this product as a matching collar for pet leashes.

It is recommended to clean the contacts weekly with alcohol or other disinfectants. Please shut down when cleaning.



### CAUTION

Remove all other types of collars. These collars will produce noise that will cause false triggers.

Please remove the collar before playing with the dog. Dog barking during play can cause unnecessary triggers.



## Frequently asked questions



### FAQ

**Q: Why does the collar not work when the dog barks ?**

**A:** There may be three reasons for this problem. The first is that the trigger sensitivity. Second, the probe does not touch the skin, so try to adjust the belt tightness to ensure good skin contact. Third, the training level is not high enough, so try to increase the training level.

**Q: Is the bark control collar safe and humane ?**

**A:** All training methods will not cause any direct harm to the pet's body, but make them feel extremely uncomfortable. But even so, do not overuse this product on pets. Please refer to all WARNING and CAUTION contents in the manual.

**Q: Other dog barking sounds or other ambient noise can trigger the collar.**

**A:** It is possible, but the probability is very low. We optimized the dog barking waveform recognition technology to enhance the ability to resist false triggers. If a false trigger occurs, please adjust the sensitivity setting appropriately.

## Troubleshooting



### Troubleshooting

If the product is abnormal during use,  
you can do the following :

**Check  
collar  
wearing**



Make sur the collar is tight enough  
and device is in the correct.

**Increase  
sensitivity**



Adjust the sensitivity setting  
to suit the usage scenario.

**Test  
product**



Check if the product is working  
properly and do the necessary tests.

**Restore  
factory  
settings**



When the product fails,  
reset the product to solve  
the problem.

**Contact  
dealer**



For more questions, please contact  
your local or online dealer.

---

# Terms of use & limitation of liability

---

# 27

## Terms & limitation



### Terms & limitation

#### 1. Term of use

Your use of this product means that you accept all terms, conditions and statements in this manual.

#### 2. Correct Use

This product is designed for pets that need training. Proper use includes reviewing the entire user manual included with the product and any specific "caution" statements.

#### 3. Prohibition of illegal or prohibited use

This product is only suitable for pets. This training device is not intended to harm or provoke pets. Using this product not in accordance with the instruction manual may violate local laws.

#### 4. Scope of responsibility

The manufacturer is not responsible for any related damage, direct, indirect, punitive, non major, and other indirect losses caused by incorrect use or abuse of this product. The buyer bears all risks and responsibilities of using this product.

#### 5. Modification of terms and conditions

The manufacturer reserves the right to change the terms, conditions and notices related to this product.



This device complies with part 15 of the FCC Rules. Operation is subject to the following two conditions :

1. This device may not cause harmful interference, and
2. This device must accept any interference received, including interference that may cause undesired operation.

**Warning : Changes or modifications not expressly approved by the party responsible for compliance could void the user's authority to operate the equipment.**

Note : this equipment has been tested and found to comply with the limits for a Class B digital device, pursuant to Part 15 of the FCC rules. These limits are designed to provide reasonable protection against harmful interference in a residential installation. This equipment generates uses and can radiate radio frequency energy and, if not installed and used in accordance with the instructions, may cause harmful interference to radio communications.

However, there is no guarantee that interference will not occur in a particular installation.

If this equipment does cause harmful interference to radio or television reception, which can be determined by turning the equipment off and on, the user is encouraged to try to correct the interference by one or more of the following measures :

- Reorient or relocate the receiving antenna.
- Increase the separation between the equipment and receiver.
- Connect the equipment into an outlet on a circuit different (p.29 from that to which the receiver is connected.)

# Certification statements

# 29



(P28 Connect the equipment into an outlet on a circuit different) from that to which the receiver is connected.

- Consult the dealer or an experienced radio tv technician for help



The company declares under its own responsibility that this product complies with the basic requirements of CE and ROHS. Without the approval of our compagny or the distributor, unauthorized changes or modifications to the equipment may violate the CE regulations, may cause the user to lose the right to operate the equipment, and invalidate the warranty



## Recycling information & battery disposal.

Please observe the regulations for electronic and electrical devices to be disposed of in the respective country. In some countries or regions, this device must be recycled.

If this device is no longer required, it must not be disposed of with normal municipal. Waste. Separate collection of spent batteries is required in many regions, check the regulations in your area before discarding spent batteries. For more recycling information, please refer to local regulations.